

# MAXIM

## MAX4358 Evaluation Kit

**Evaluates: MAX4358**

### General Description

The MAX4358 evaluation kit (EV kit) is an assembled and tested circuit board that demonstrates a crosspoint switch with support for an optional on-screen display circuit. The MAX4358 is a 32 x 16 crosspoint switch with fast multiplexer inputs and partial update capability. The EV kit provides access to four of the inputs and four of the outputs. Windows 95/98<sup>®</sup> software provides a handy user-interface to exercise the MAX4358's features.

### Component List

REFERENCE	QTY	DESCRIPTION
C1-C20, C23	21	0.1 $\mu$ F, 10V ceramic capacitors
C21, C22	2	10 $\mu$ F, 10V tantalum capacitors
J1	1	Female right-angle 2 x 25 header
J2	1	Female right-angle 2 x 13 header
J3	1	DB25 male right-angle connector
J4-J11	8	BNC female jacks
JU1-JU4	4	2-pin headers
R1	1	8-pin sip socket strip
R1	1	75 $\Omega$ $\pm$ 2% 8-pin sip resistor pack, isolated circuit
R2, R3, R4, R9-R13, R51, R52, R53	11	100k $\Omega$ $\pm$ 5% resistors
R5-R8	4	75 $\Omega$ $\pm$ 1% resistors
R14-R25	12	10k $\Omega$ $\pm$ 5% resistors
R26-R50	25	27 $\Omega$ $\pm$ 5% resistors
R54	1	1k $\Omega$ $\pm$ 5% resistor
TB1	1	Five-circuit terminal block
U1	1	MAX4358ECE, 144-pin TQFP
U2	1	MAX353CSE/DG413CY, 16-pin SO
U3	1	74HC14 hex Schmitt-trigger inverter
None	1	MAX4358 PC board
None	1	Parallel port I/O extension cable Digi-Key AE1012-ND
None	1	Clip-on EMI suppression core w/ case, Fair-Rite 0444164281, or Mouser 623-0444164281
None	1	3.5in software disk
None	1	MAX4358 data sheet
None	1	MAX4358 EV kit data sheet

Windows 95/98 is a registered trademark of Microsoft Corp.

### Features

- ◆ Proven PC Board Layout
- ◆ Convenient On-Board Test Points
- ◆ Fully Assembled and Tested
- ◆ Optional On-Screen Display (Companion Board)

### Ordering Information

PART	TEMP RANGE	IC PACKAGE
MAX4358EVKIT	0°C to +70°C	144 TQFP

### MAX4358 EV Kit Files

INSTALL.EXE	Installs the EV kit files on your computer
MAX4358.EXE	Application program
LPTCON.VXD	Required parallel port driver

### Quick Start

#### Recommended Equipment

Before you begin, you will need the following equipment:

- MAX4358EVKIT
  - A dual, DC power supply
  - A computer running Windows 95/98
  - A spare parallel port
  - A 25-pin, I/O extension cable
- 1) With the power off, connect the DC power supply to the MAX4358EVKIT at the terminal block.
  - 2) Connect the 25-pin I/O extension cable from the computer's parallel port to the EV kit. The software uses a loopback connection to confirm that the correct port has been selected.
  - 3) Ensure that the jumper settings are correct (see Table 1, *Jumper Functions*).
  - 4) Connect input signals to IN00-IN03 and connect outputs OUT00-OUT03 to monitors. Ensure that the signals are terminated properly. Unused inputs may be left unconnected.
  - 5) Install the MAX4358 EV kit software on your com-

# MAX4358 Evaluation Kit

puter by running the INSTALL.EXE program on the floppy disk. The program files are copied and icons are created for them in the Windows Start Menu.

- 6) Turn on the power supply.
- 7) Start the MAX4358 program by opening its icon in the Start Menu.
- 8) To route the signal from input IN00 to output OUT00, go to the Output 00 combo box, and change the selection from "Disabled" to "Input 00". Optionally change the gain to "1V/V" or "2V/V". A message will appear at the bottom of the screen, "Pending Update". Click the "Send 15-bit Update" button to send the command to the hardware. You should now observe input signal IN00 appearing on output OUT00.

## Software Description

The main window controls a single MAX4358. Each of the matrix outputs has a corresponding drop-down combo box that selects its input source. Although the MAX4358EVKIT board only has BNC connections for IN00–IN03 and OUT00–OUT03, the evaluation software can be used to command all outputs. This way, the evaluation software can be used as a diagnostic during initial product development.

### Initializing the Entire Matrix

The entire crosspoint can be initialized by means of a 112-bit synchronous serial command. First, use the drop-down combo boxes to select the desired input channel for each output. Optionally set 1V/V or 2V/V gain. Next, click on the "Send 112-bit Full Initialization" command button to transmit the command to the hardware.

### 15-Bit Update Command

First, use one of the drop-down combo boxes to select the desired input channel for the single output to be updated. Optionally set 1V/V or 2V/V gain. Next, click on the "Send 15-bit Update" command button to transmit the update command to the hardware.

### Options

To make the evaluation software transmit updated commands as soon as the corresponding combo box is changed, go to the Updates menu and check "Send updates when control is changed". To make the evaluation software display each update command before transmitting it, check "Show alert on updates."

To observe the command waveforms on an analog oscilloscope, use the Repeat menu to make the evaluation software repeat its most recent initialization or update command at an observable rate.

The Reset menu can be used to reset all of the main window's drop-down combo boxes to Disabled, their initial state. Reset Software only changes the controls in the main window; it does not affect the hardware. Reset Hardware pulses the hardware reset signal, placing the MAX4358 in its initial state with all outputs disabled.

### Supporting Larger Crosspoints

Up to sixteen MAX4358's can be daisy-chained together to form a larger crosspoint matrix. In this configuration, each MAX4358 should have a unique address selection, set by inputs A0–A3. Although the evaluation software is only designed to control a single MAX4358, it can target any of the sixteen A0–A3 addresses, by setting the corresponding A0–A3 check boxes at the top of the main window.

## Detailed Description

U1, the MAX4358, is a 32 × 16 crosspoint switch with fast multiplexer inputs and partial update capability. The MAX4358 EV kit has BNC connectors for four of the inputs and four of the outputs. Additionally, eight outputs as well as OSDFILL0...OSDFILL7 and OSDKEY0...OSDKEY7 connect to the optional on-screen display kit.

Sip resistor pack R1 provides optional 75Ω termination resistors on IN00–IN03. Inputs IN04–IN07 also have 75Ω terminations. Inputs IN08–IN31 are tied together to test point TP1 and jumper JU5, for all-hostile crosstalk testing. Outputs OUT00–OUT03 have 75Ω series resistors for back or reverse termination. Also, outputs OUT00–OUT07 connect to the optional on-screen display kit through 27Ω resistors. The remaining outputs are left unconnected.

See Figure 1, *MAX4358 EV Kit Schematic* and refer to the MAX4358 data sheet.

### Troubleshooting

**Problem: Cannot find MAX4358 parallel port connection.**

Ensure that the I/O extension cable is connected to a parallel port, and not a SCSI or other type of port. Verify that the supplied LPTCON.VXD is in the same directory as MAX4358.EXE. If a local printer driver is installed, temporarily disable it. The software will not work if the program icon is dragged onto the Windows desktop; instead, install the software into a subdirectory, such as C:\MAX4358. The software can also be run directly on its floppy disk, as long as both MAX4358.EXE and LPTCON.VXD are in the same directory.

# MAX4358 Evaluation Kit

**Problem: Output signal amplitude is lower than expected.**

Typical video equipment, such as the VM700 and video monitors, have built-in terminations. Ensure that the signal path is not double-terminated.

**Table 1. Jumper Functions**

JUMPER	POSITION	FUNCTION
JU1	Closed*	Address selection A3 = 0
	Open	Address selection A3 = 1
JU2	Closed*	Address selection A2 = 0
	Open	Address selection A2 = 1
JU3	Closed*	Address selection A1 = 0
	Open	Address selection A1 = 1
JU4	Closed*	Address selection A0 = 0
	Open	Address selection A0 = 1
JU5	Closed*	IN08...IN31 connected to ground
	Open	IN08...IN31 driven by TP1

\*Default configuration.

**Evaluates: MAX4358**

# MAX4358 Evaluation Kit

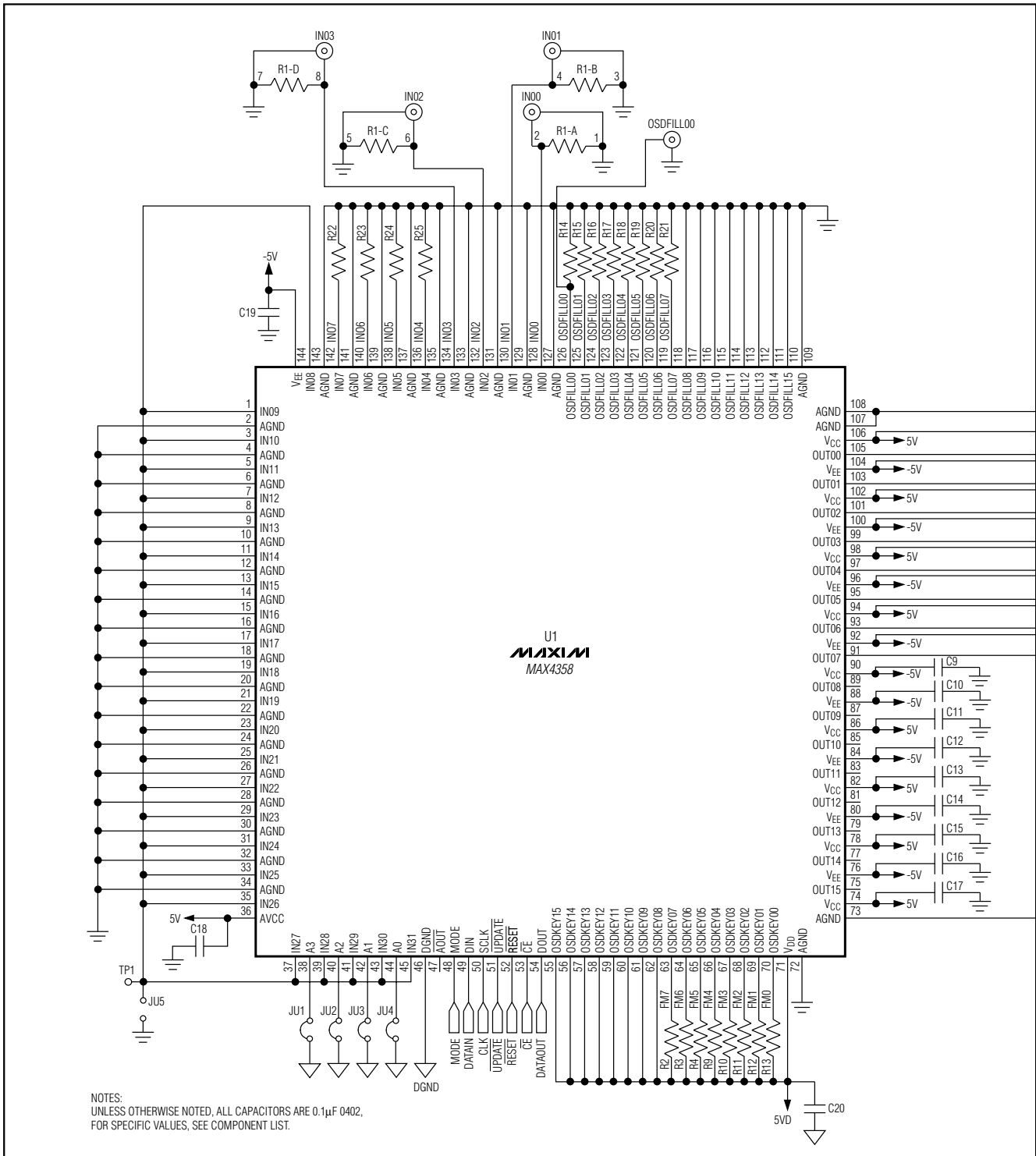

Figure 1a. MAX4358 EV Kit Schematic

# MAX4358 Evaluation Kit

Evaluates: MAX4358

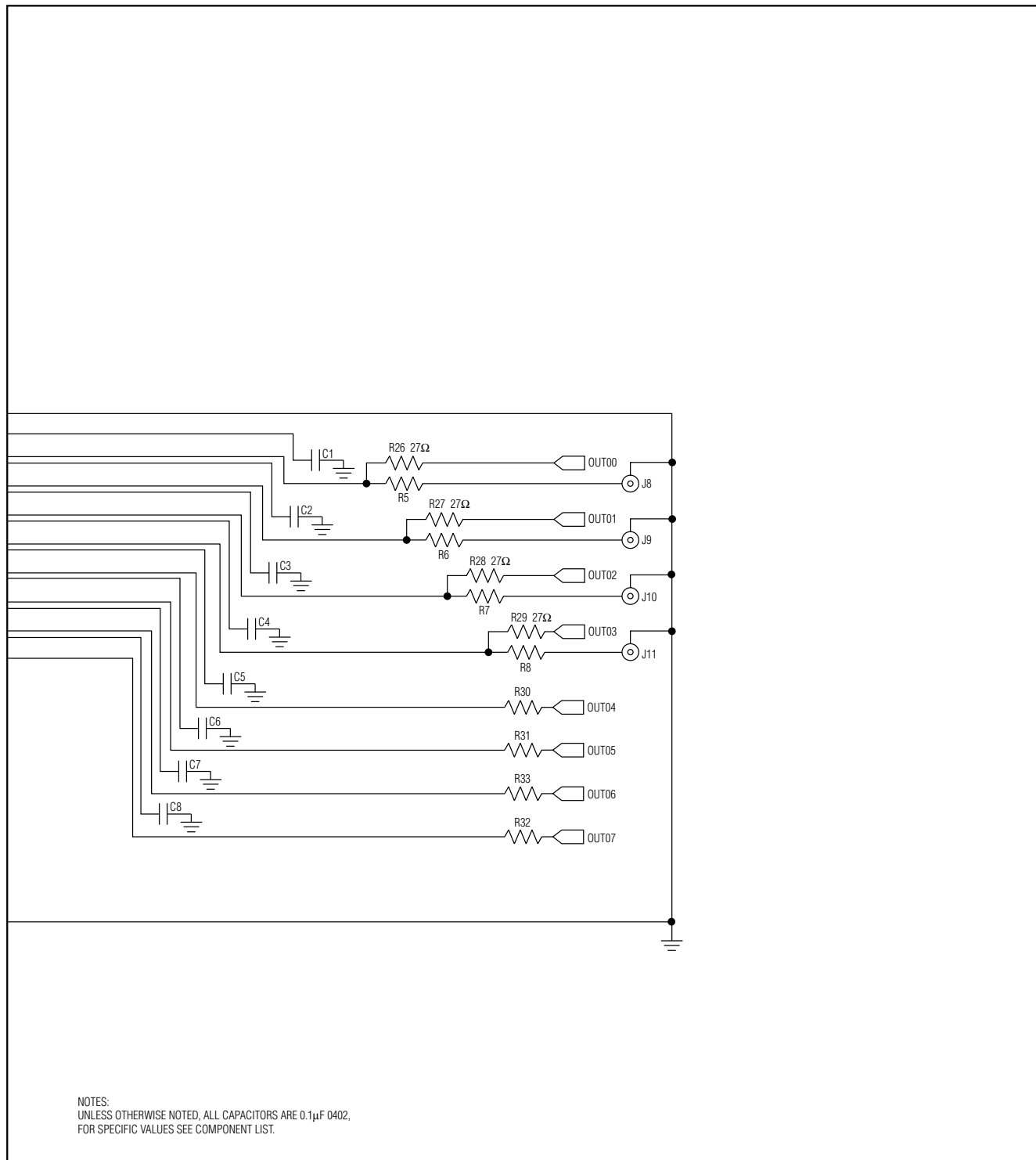

Figure 1a. MAX4358 EV Kit Schematic (continued)

# MAX4358 Evaluation Kit

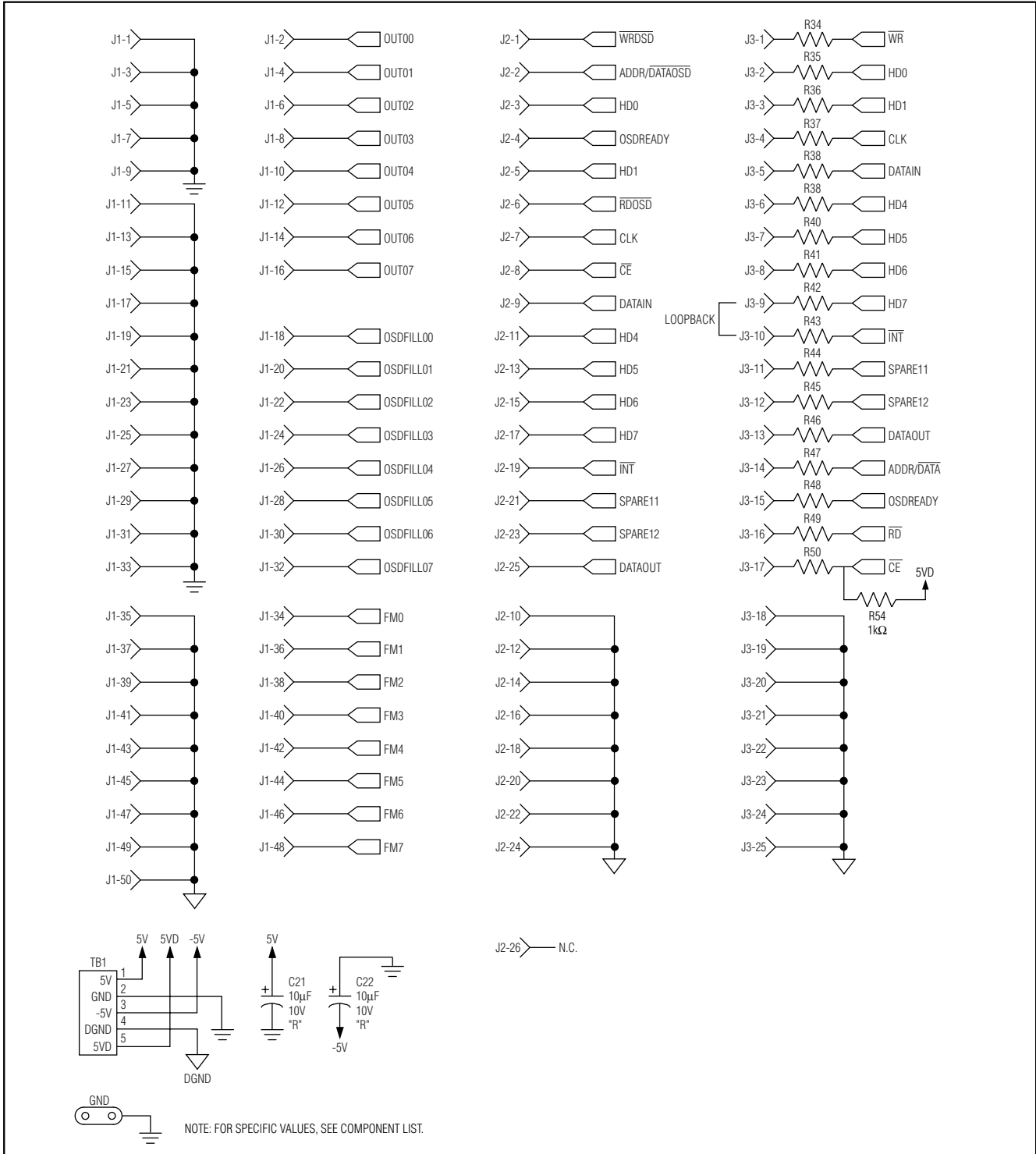

Figure 1b. MAX4358 EV Kit Schematic

# MAX4358 Evaluation Kit

Evaluates: MAX4358

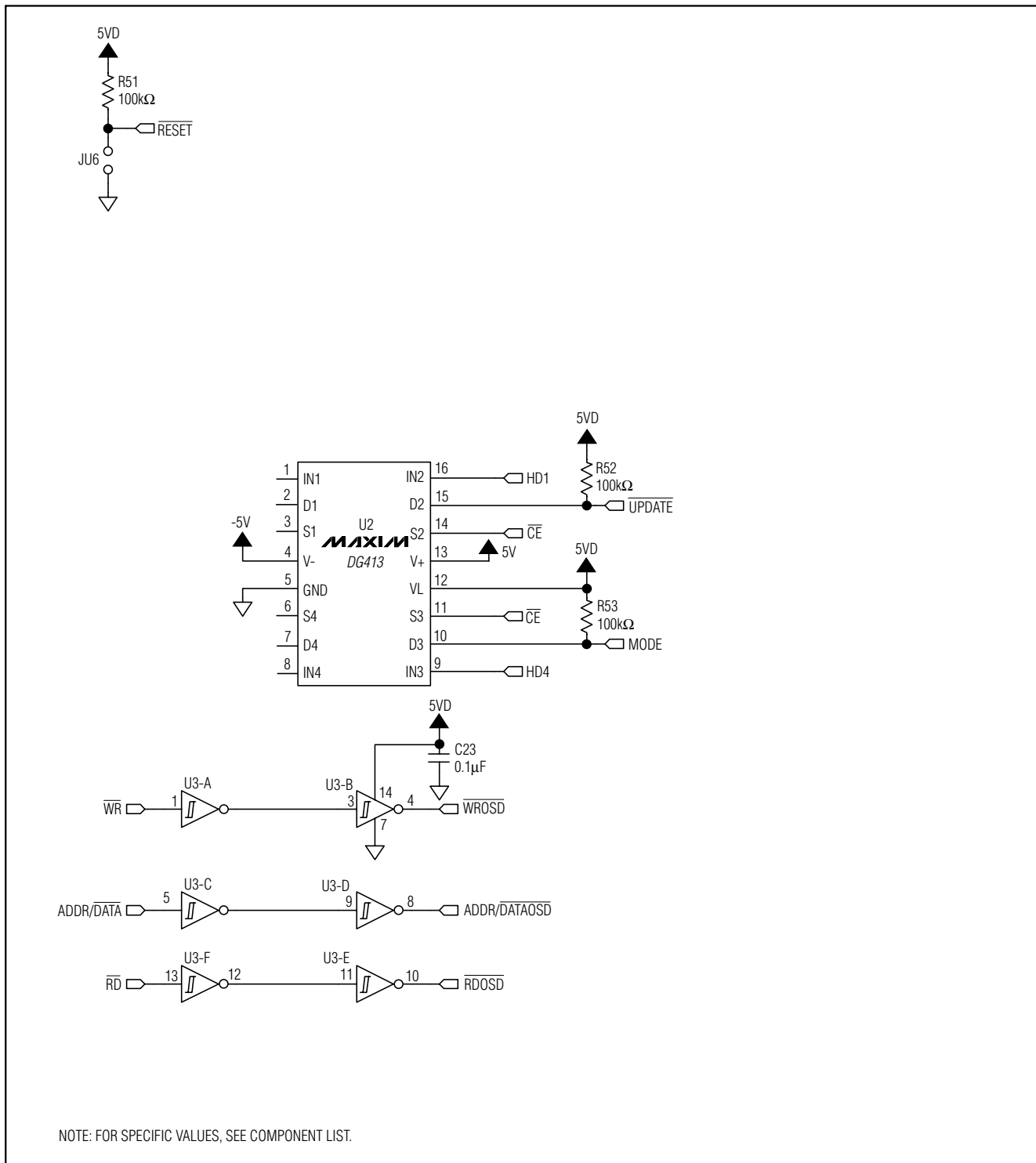

Figure 1b. MAX4358 EV Kit Schematic (continued)

# MAX4358 Evaluation Kit

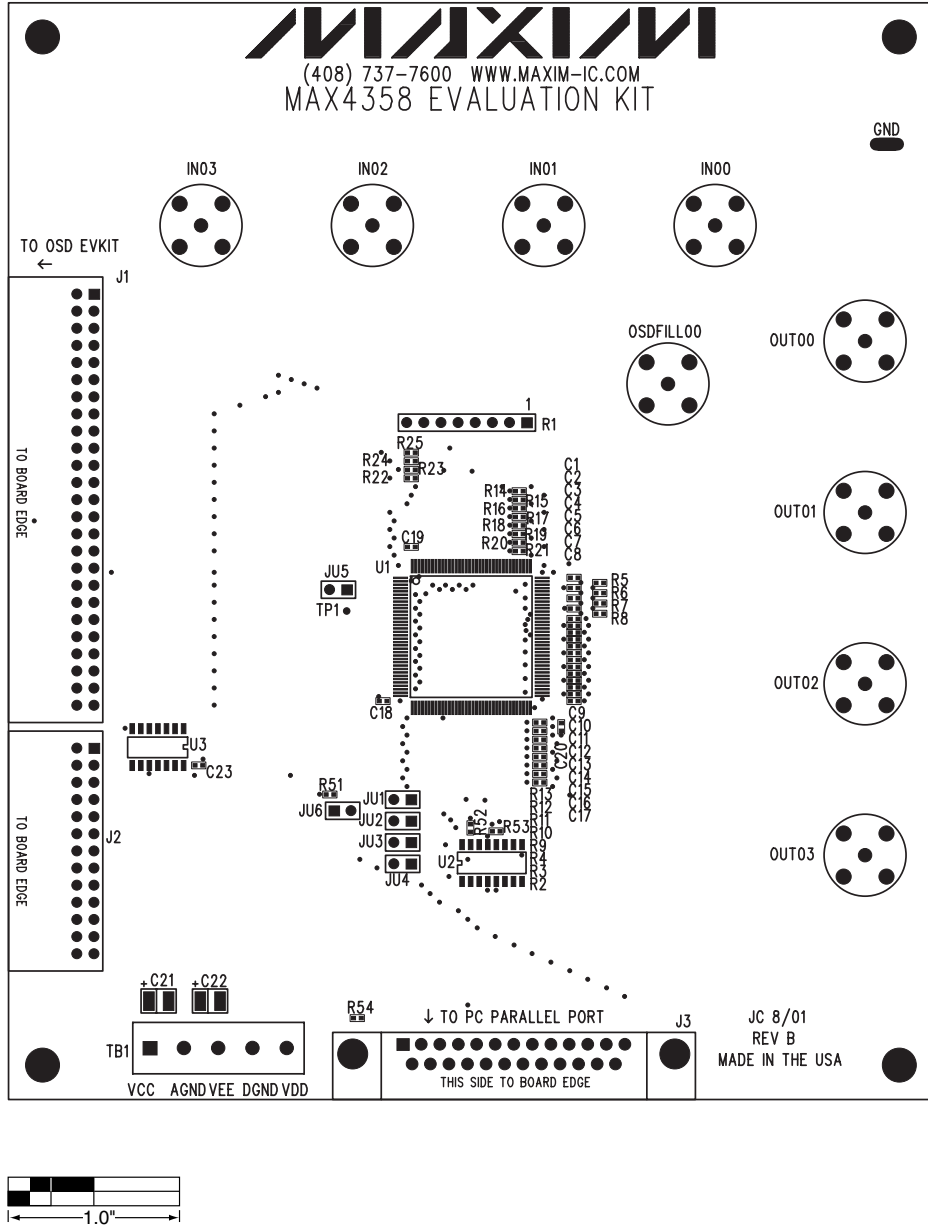

Figure 2. MAX4358 EV Kit Component Placement Guide—Component Side



# MAX4358 Evaluation Kit

Evaluates: MAX4358

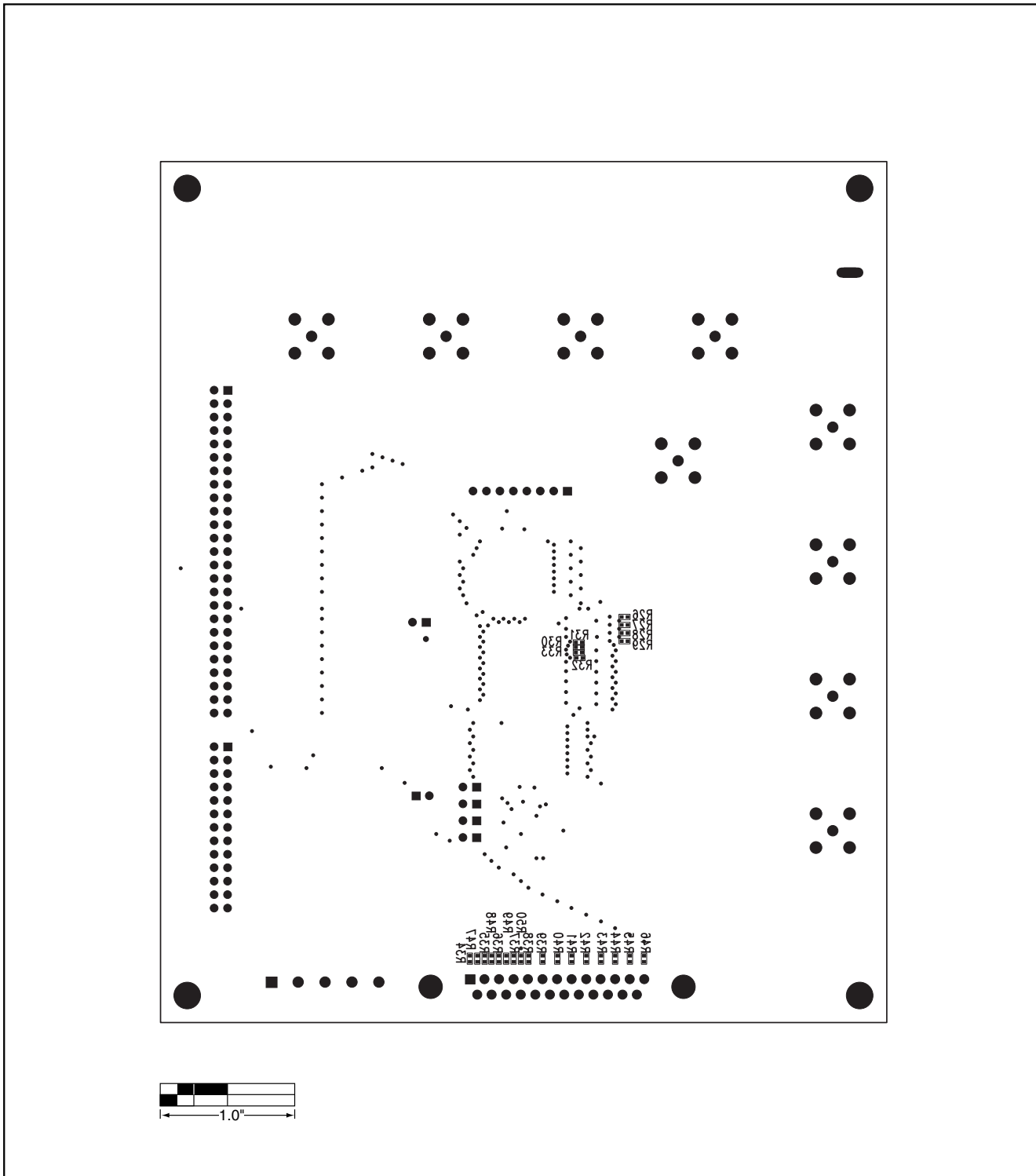

Figure 3. MAX4358 EV Kit Component Placement Guide—Solder Side

# MAX4358 Evaluation Kit

Evaluates: MAX4358

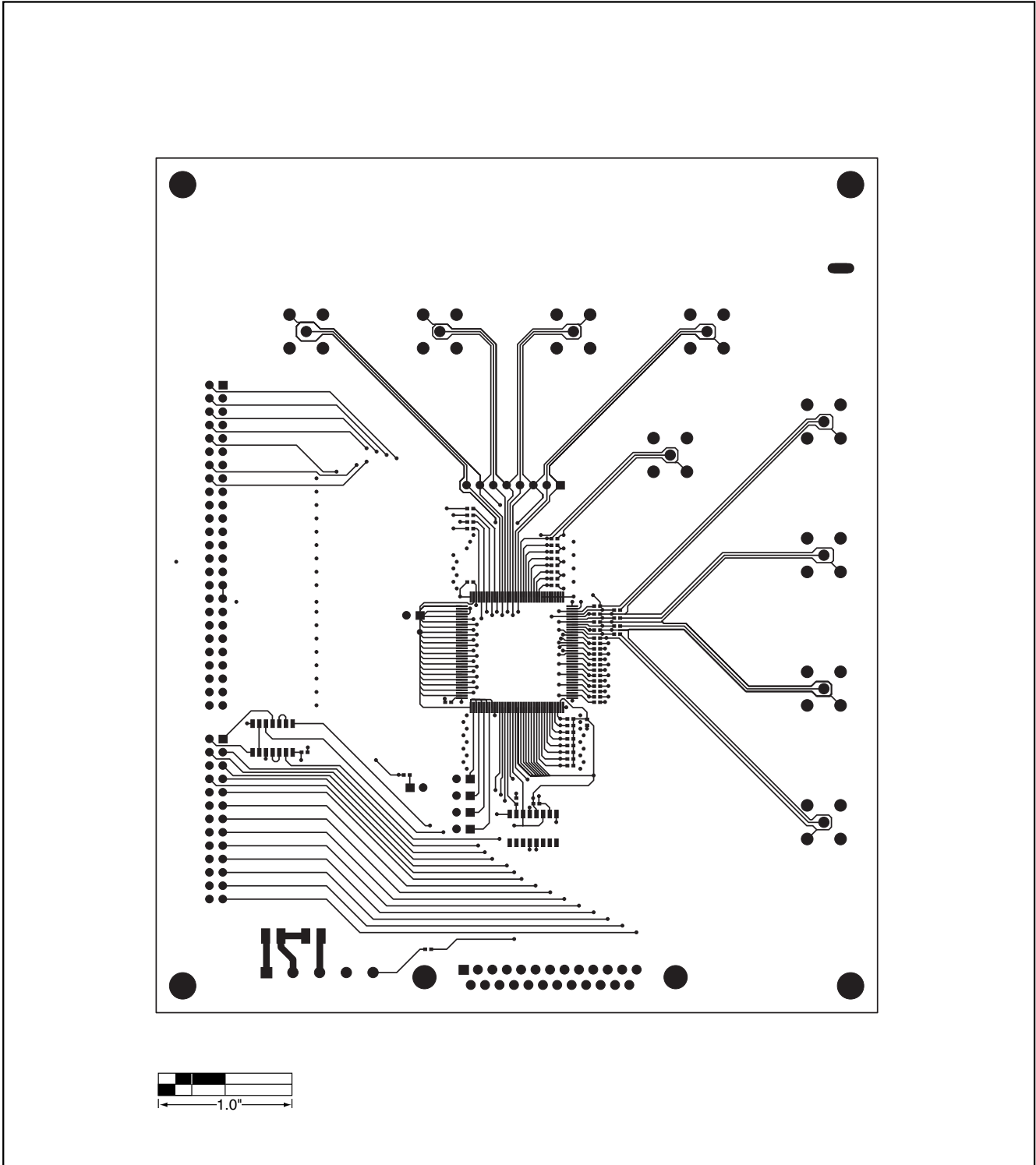

Figure 4. MAX4358 EV Kit PC Board Layout—Layer 1

# MAX4358 Evaluation Kit

Evaluates: MAX4358

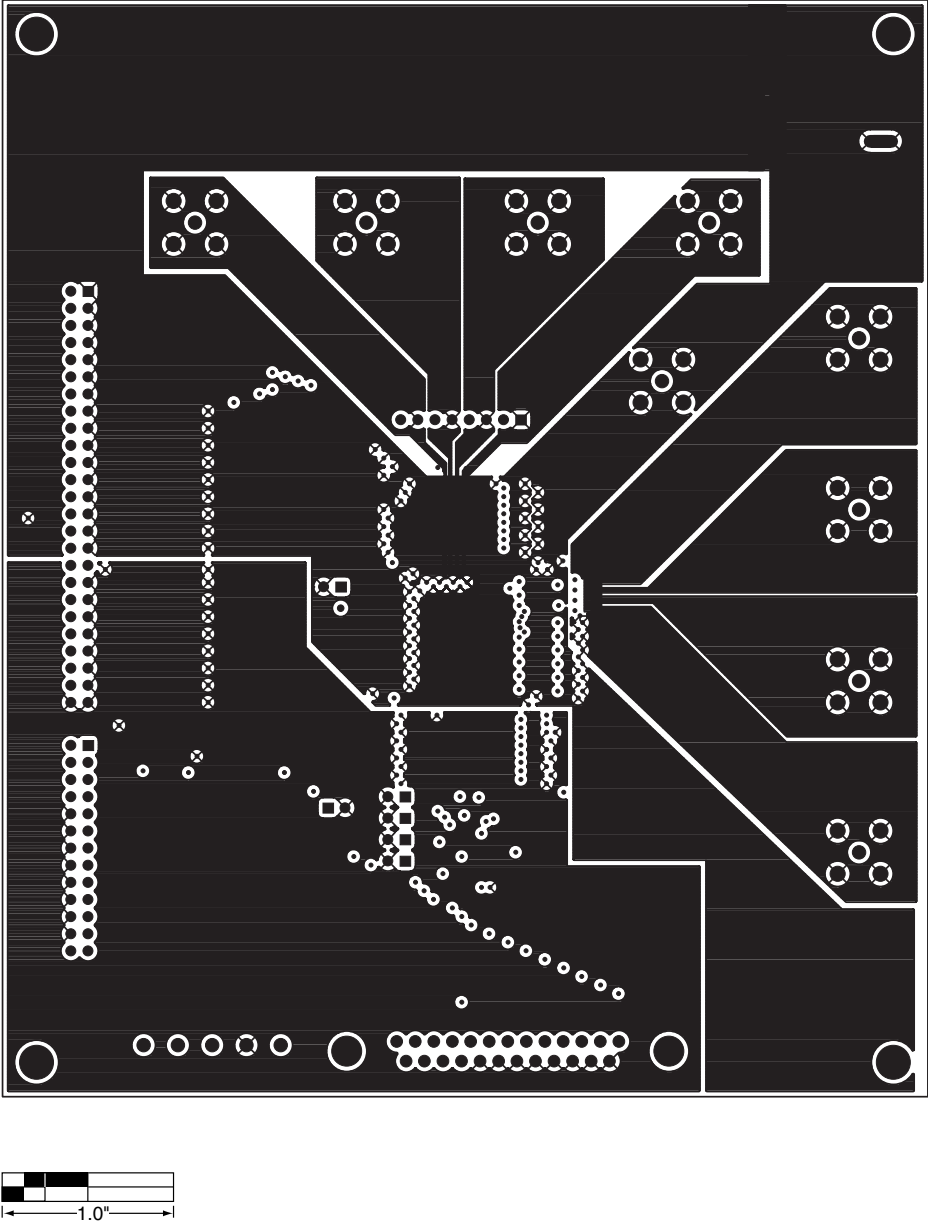

Figure 5. MAX4358 EV Kit PC Board Layout—Layer 2

# MAX4358 Evaluation Kit

Evaluates: MAX4358

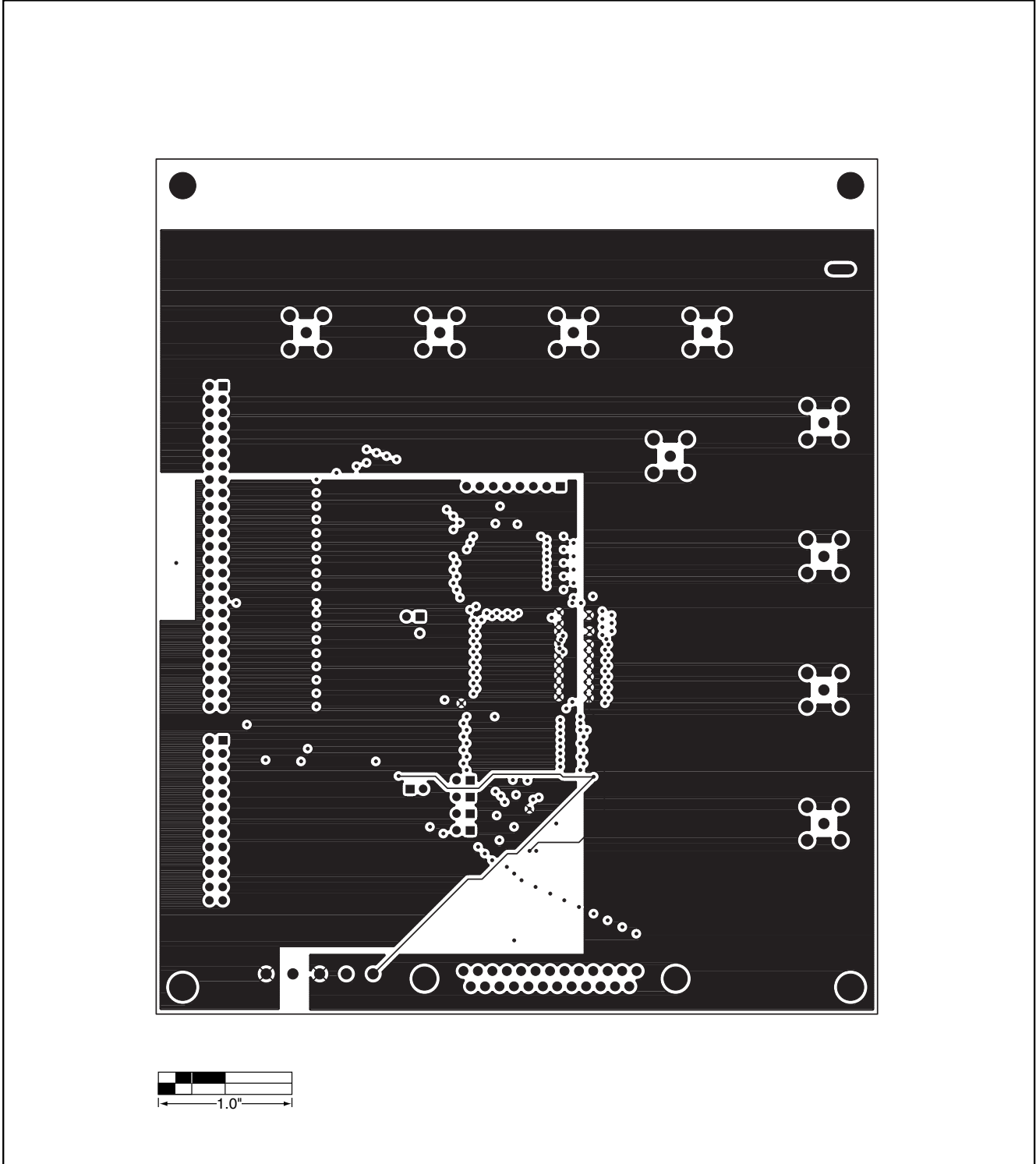

Figure 6. MAX4358 EV Kit PC Board Layout—Layer 3

# MAX4358 Evaluation Kit

Evaluates: MAX4358

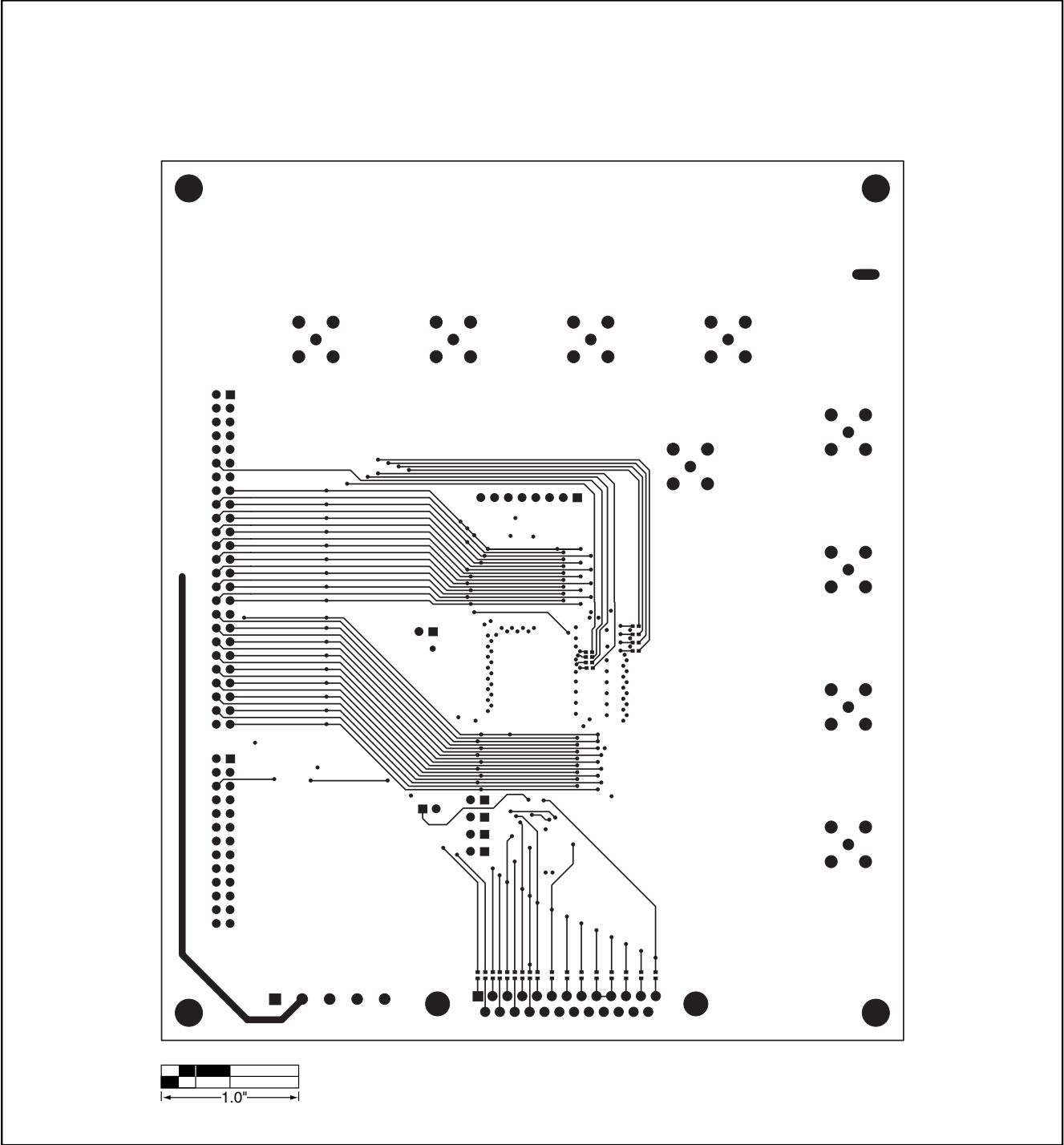

Figure 7. MAX4358 EV Kit PC Board Layout—Layer 4

Maxim cannot assume responsibility for use of any circuitry other than circuitry entirely embodied in a Maxim product. No circuit patent licenses are implied. Maxim reserves the right to change the circuitry and specifications without notice at any time.

Maxim Integrated Products, 120 San Gabriel Drive, Sunnyvale, CA 94086 408-737-7600 13